

CATALOG MIDI
LISTA PRETURI
COMPONENTE RULOURI PVC



Sediu: 810213 Brăila, Str. Grivița 91, tel/fax: +4 0239 612 867; e-mail: office@artlyl.ro; www.artlyl.ro

ART LYL DESIGN

IBAN :RO52 BRDE 090S V026 1577 0900 BRD-AG BRĂILA, Reg.Com.J 09/616/2002, CIF: RO 15108290

NR. CRT.	IMAGINE PRODUS	AMBALAJ	DENUMIRE PRODUS	CULOARE	COD	PRET (EURO fara TVA)
1.		(6 ml/buc) 30 ml	CASETA 140	ALB	1L-1401	
			CASETA 140	MARO	1L-1402	
			CASETA 165	ALB	1L-1651	
			CASETA 165	MARO	1L-1652	
			CASETA 180	ALB	1L-1801	
			CASETA 180	MARO	1L-1802	
2.		25 perechi	CAPAC 140	ALB	2L-1401	
			CAPAC 140	MARO	2L-1402	
			CAPAC 165	ALB	2L-1651	
			CAPAC 165	MARO	2L-1652	
			CAPAC 180	ALB	2L-1801	
			CAPAC 180	MARO	2L-1802	
3.		50 perechi	GHIDAJ LAMELA	ALB	3L-01	
				MARO	3L-02	
4.		(5,4 ml/sina) 54 ml	SINA GHIDAJ 53 X 22 CU GARNITURA	ALB	4L-01	
				MARO	4L-02	



CATALOG MIDI
LISTA PRETURI
COMPONENTE RULOURI PVC



Sediu: 810213 Brăila, Str. Grivița 91, tel/fax: +4 0239 612 867; e-mail: office@artlyl.ro; www.artlyl.ro

ART LYL DESIGN

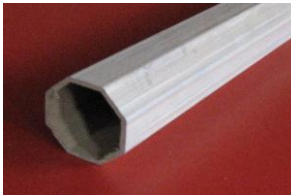
IBAN :RO52 BRDE 090S V026 1577 0900 BRD-AG BRĂILA, Reg.Com.J 09/616/2002, CIF: RO 15108290

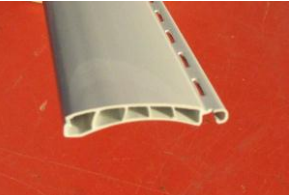
NR. CRT.	IMAGINE PRODUS	AMBALAJ	DENUMIRE PRODUS	CULOARE	COD	
5.		(4,4 ml/buc) 44 ml	AX OCTOGONAL PVC	GRI	5L-00	
6		100 seturi	ROLA+DOP 40 mm	GRI	6L-00	
7						
8.		100 bucati	RULMENT METALIC	NATUR	7L-00	
9.		220 ml	LAMELA PVC 37 mm	ALB	S1	
				IMITATIE STEJAR	S5	
				IMITATIE BRAD	S2	
				CREM	S7	
				BEJ	S6	
MARO	S4					

CATALOG MIDI
LISTA PRETURI
COMPONENTE RULOURI PVC



Sediu: 810213 Brăila, Str. Grivița 91, tel/fax: +4 0239 612 867; e-mail: office@artlyl.ro; www.artlyl.ro

ART LYL DESIGN

IBAN :RO52 BRDE 090S V026 1577 0900 BRD-AG BRĂILA, Reg.Com.J 09/616/2002, CIF: RO 15108290

NR. CRT.	IMAGINE PRODUS	AMBALAJ	DENUMIRE PRODUS	CULOARE	COD	
11		44 ml	LAMELA FINALA METALICA	ALB	8L-01	
				MARO	8L-02	
12		100 bucati	OPRITOR ASCUNS	ALB	9L-01	
13		100 bucati	OPRITOR EXTERIOR	ALB	19L-01	
				MARO	19L-02	
15 A		100 bucati	ROLA GHIDARE METALICA PENTRU CHINGA – PRINDERE VERTICALA	NATUR	10L-00	





CATALOG MIDI
LISTA PRETURI
COMPONENTE RULOURI PVC



Sediu: 810213 Brăila, Str. Grivița 91, tel/fax: +4 0239 612 867; e-mail: office@artlyl.ro; www.artlyl.ro

ART LYL DESIGN

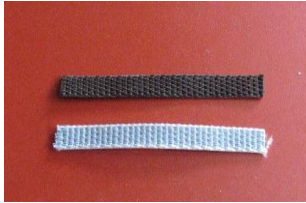
IBAN :RO52 BRDE 090S V026 1577 0900 BRD-AG BRĂILA, Reg.Com.J 09/616/2002, CIF: RO 15108290

NR. CRT.	IMAGINE PRODUS	AMBALAJ	DENUMIRE PRODUS	CULOARE	COD	
15 B		100 bucati	ROLA GHIDARE METALICA PENTRU CHINGA – PRINDERE TAMPLARIE	NATUR	11L-00	
15 C		100 bucati	ROLA GHIDARE PVC PENTRU CHINGA – PRINDERE TAMPLARIE	ALB	12L-01	
				MARO	12L-02	
16 A		100 ml	CHINGA 14 mm	ALB	13L-01	
				MARO	13L-02	
16 B		300 ml	SNUR	ALB	14L-01	
				MARO	14L-02	





CATALOG MIDI
LISTA PRETURI
COMPONENTE RULOURI PVC



Sediu: 810213 Brăila, Str. Grivița 91, tel/fax: +4 0239 612 867; e-mail: office@artlyl.ro; www.artlyl.ro

ART LYL DESIGN

IBAN :RO52 BRDE 090S V026 1577 0900 BRD-AG BRĂILA, Reg.Com.J 09/616/2002, CIF: RO 15108290

NR. CRT.	IMAGINE PRODUS	AMBALAJ	DENUMIRE PRODUS	CULOARE	COD	
17 A		70 bucati	AUTOMAT CHINGA	ALB	15L-01	
				MARO	15L-02	
17 B		70 bucati	AUTOMAT SNUR	ALB	25L-02	
				MARO	25L-02	
18		250 bucati	DIBLU	ALB	16L-01	
				MARO	16L-02	
19 A		100 bucati	SCRIPETE PENTRU SNUR + ARC 100	ALB	17L-01	
MARO				17L-02		
19 B			SCRIPETE PENTRU SNUR + ARC 200	ALB	27L-01	
				MARO	27L-02	

PRETURILE NU CONTIN CHELTUIELILE DE TRANSPORT .

CATALOG MIDI
LISTA PRETURI
COMPONENTE RULOURI PVC



Sediu: 810213 Brăila, Str. Grivița 91, tel/fax: +4 0239 612 867; e-mail: office@artlyl.ro; www.artlyl.ro

ART LYL DESIGN

IBAN :RO52 BRDE 090S V026 1577 0900 BRD-AG BRĂILA, Reg.Com.J 09/616/2002, CIF: RO 15108290

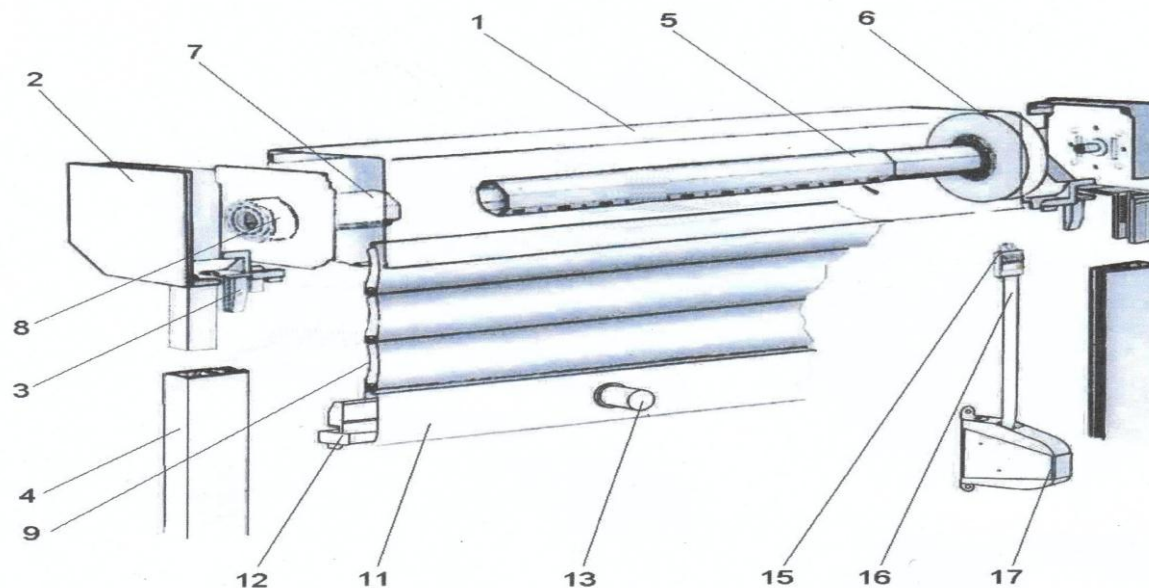

- 1- CASETA
- 2- CAPAC
- 3- GHIDAJ LAMELA
- 4- SINA GHIDAJ
- 5- AX OCTOGONAL PVC
- 6- ROLA
- 7- DOP

- 8 - RULMENT METALIC
- 9- LAMELA 37 mm
- 11- LAMELA FINALA
- 12- OPRITOR ASCUNS
- 13- OPRITOR EXTERIOR
- 15- ROLA GHIDARE
- 16- CHINGA / SNUR
- 17- AUTOMAT CHINGA / SNUR